

REV/ISS	AMENDMENTS	DRAWN	CHKD	D.O.	APVD	DATE
04A	CCO 1603/004 1603/005 1603/006	CJK				05/11/99
03A	CCO 1603/003	CJK	SP			6/10/99
02A	CCO 1603/001 & 002	CJK				24/09/99
01A	NEW PA FOR 400-470 MHZ	CJK	JJ			10/06/99

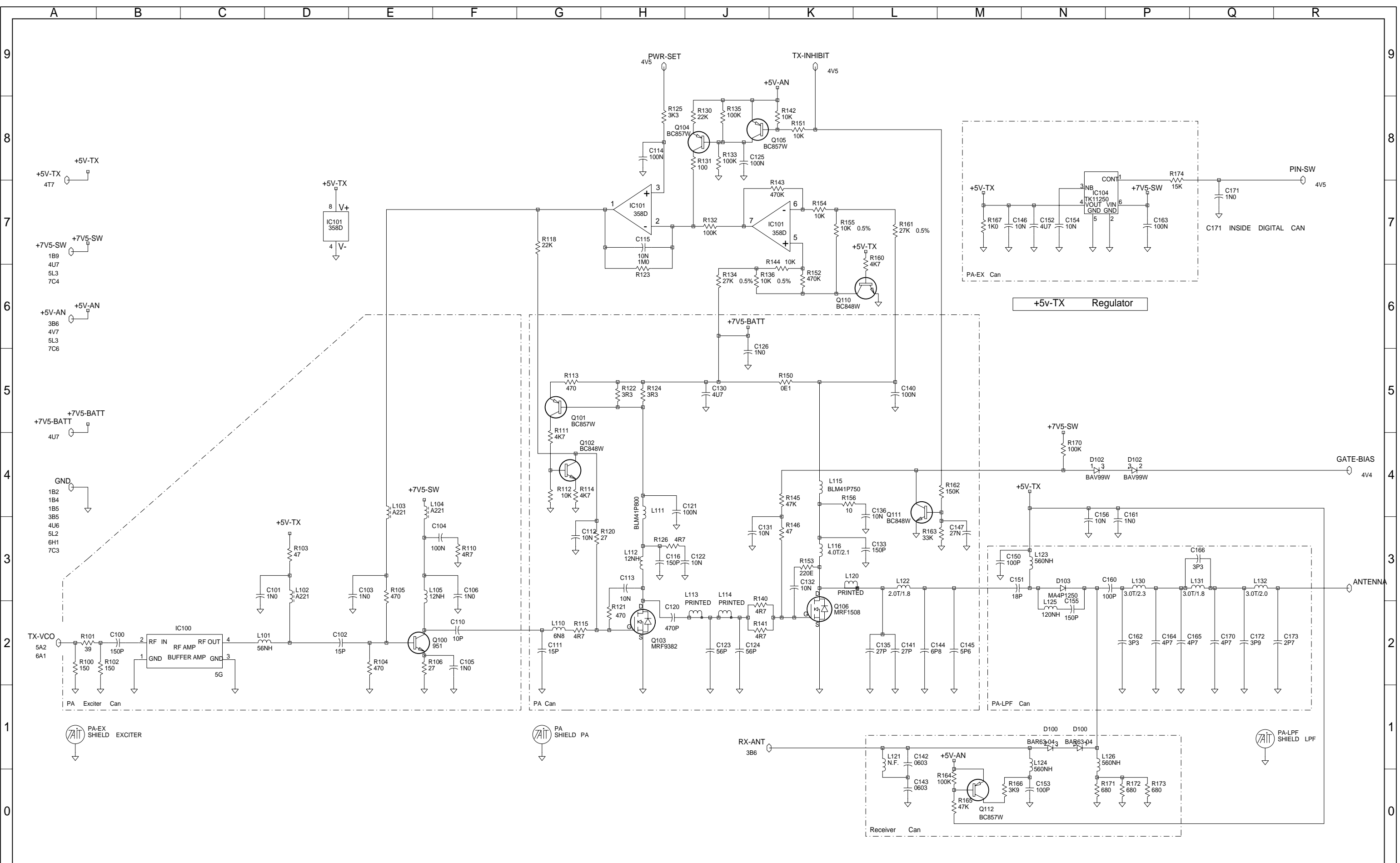

© TAIT ELECTRONICS
 ORCA : 400-470MHZ
 SYSTEM DIAGRAM
 IPN: 220-01603-04 ISSUE: A ID: 2.S.C. 1
 PROJECT: ORCA DESIGNER: CJK FILE NAME: 160304a FILE DATE: 9-Nov-99 NO.SHEETS: 7



© TAIT ELECTRONICS
 ORCA : 400-470MHZ
 POWER AMPLIFIER

IPN: 220-01603-04	ISSUE: A	ID: 2.S.C. 2
PROJECT: ORCA	DESIGNER: CJK	FILE NAME: 160304a
	FILE DATE: 9-Nov-99	NO.SHEETS: 7

REV/ISS	AMENDMENTS	DRAWN	CHKD	D.O.	APVD	DATE
A						

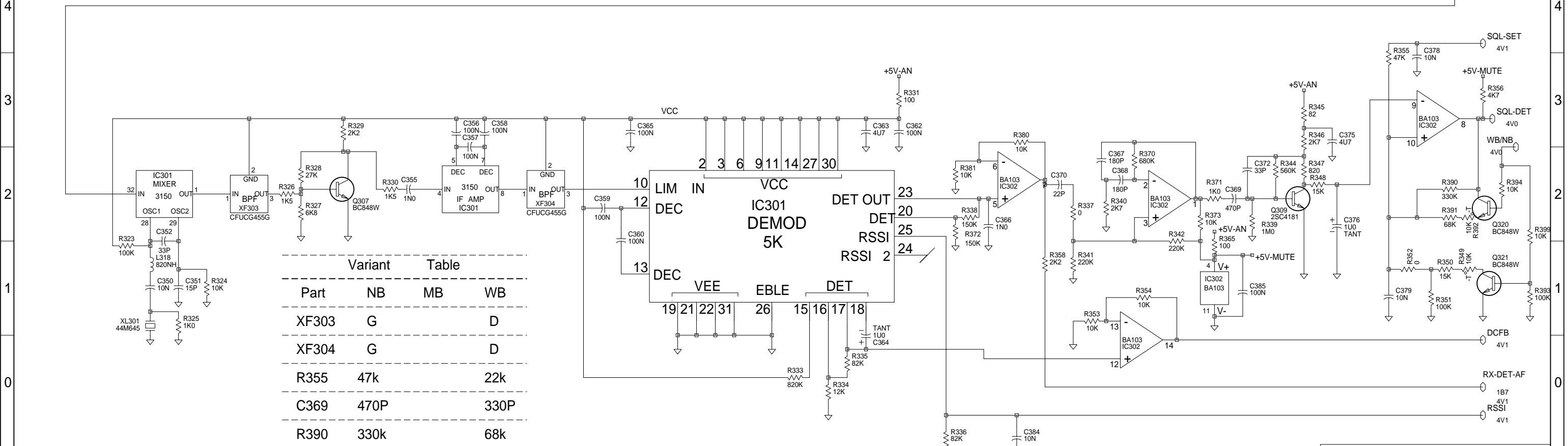
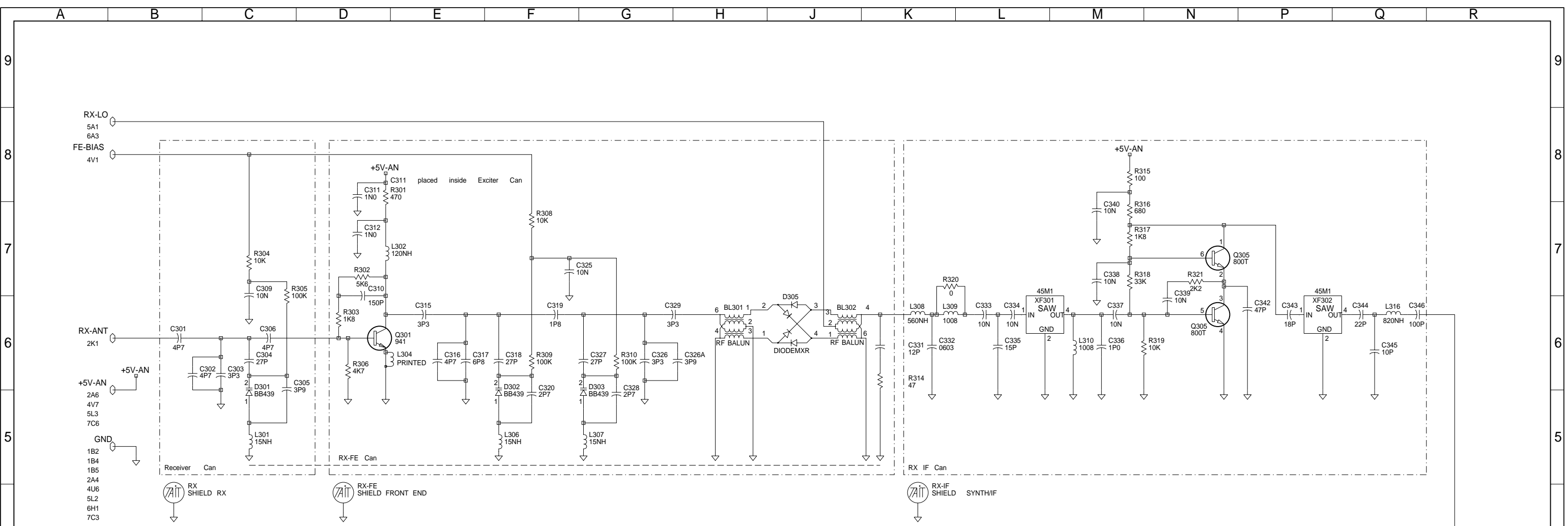

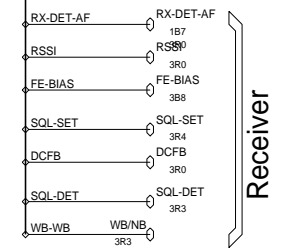
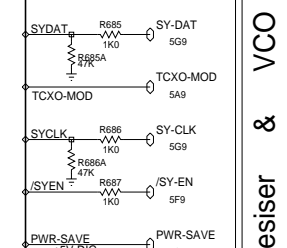
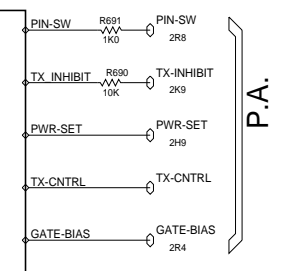
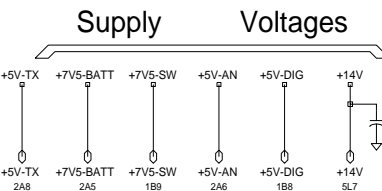
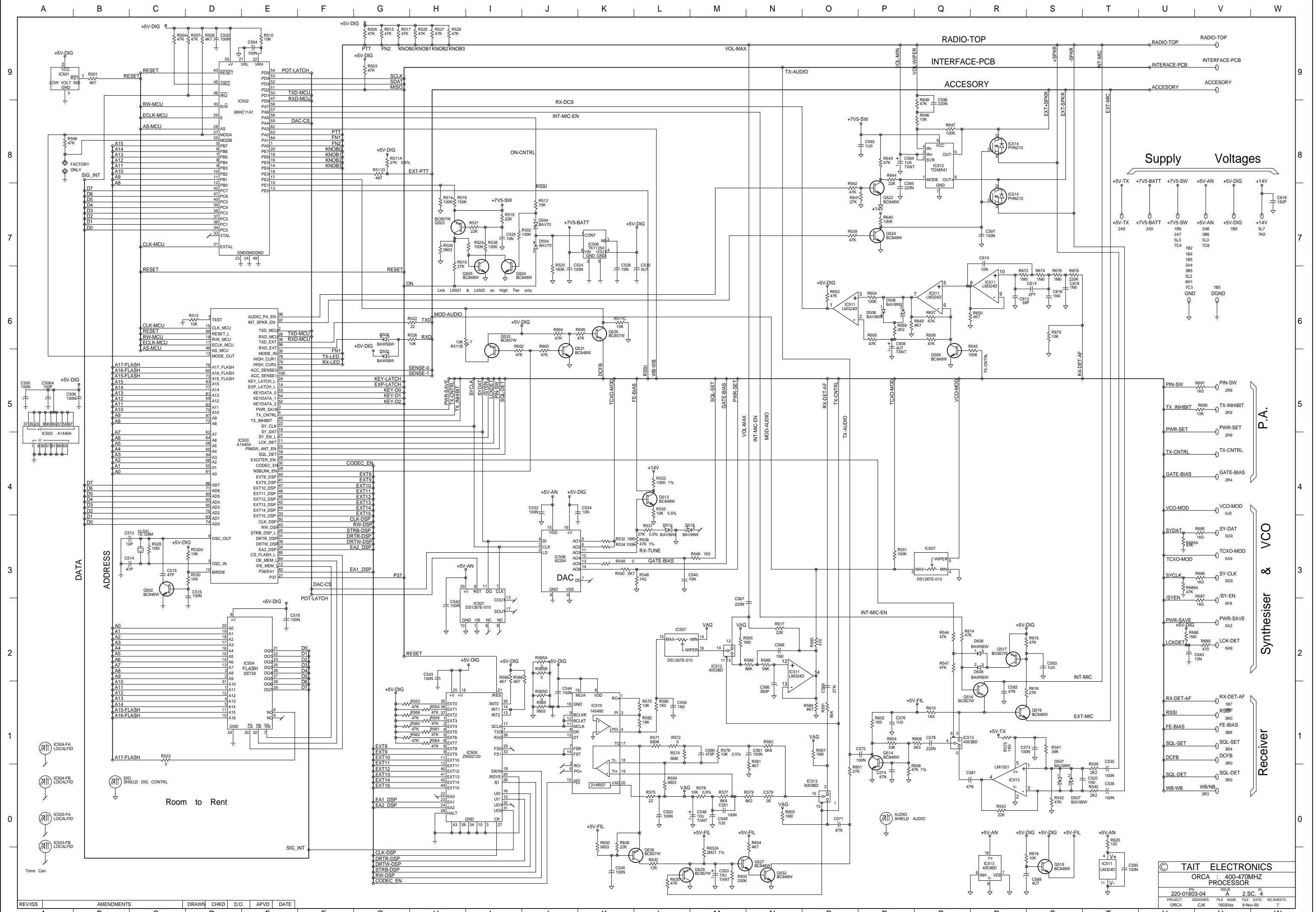

REV/ISS	AMENDMENTS	DRAWN	CHKD	D.O.	APVD	DATE
A	B	C	D	E	F	G

© TAIT ELECTRONICS
 ORCA : 400-470MHZ
 PROCESSOR
 220-01603-04
 2-SC-4
 PROJECT DESIGNER: FILE NAME: FILE DATE: NO SHEETS: 7
 ORCA CJK 160304a 9-Nov-99

ROOM TO RENT
 SIG_INT
 Toms Can
 IC504-FA LOCALFID
 IC504-FB LOCALFID
 IC503-FA LOCALFID
 IC503-FB LOCALFID

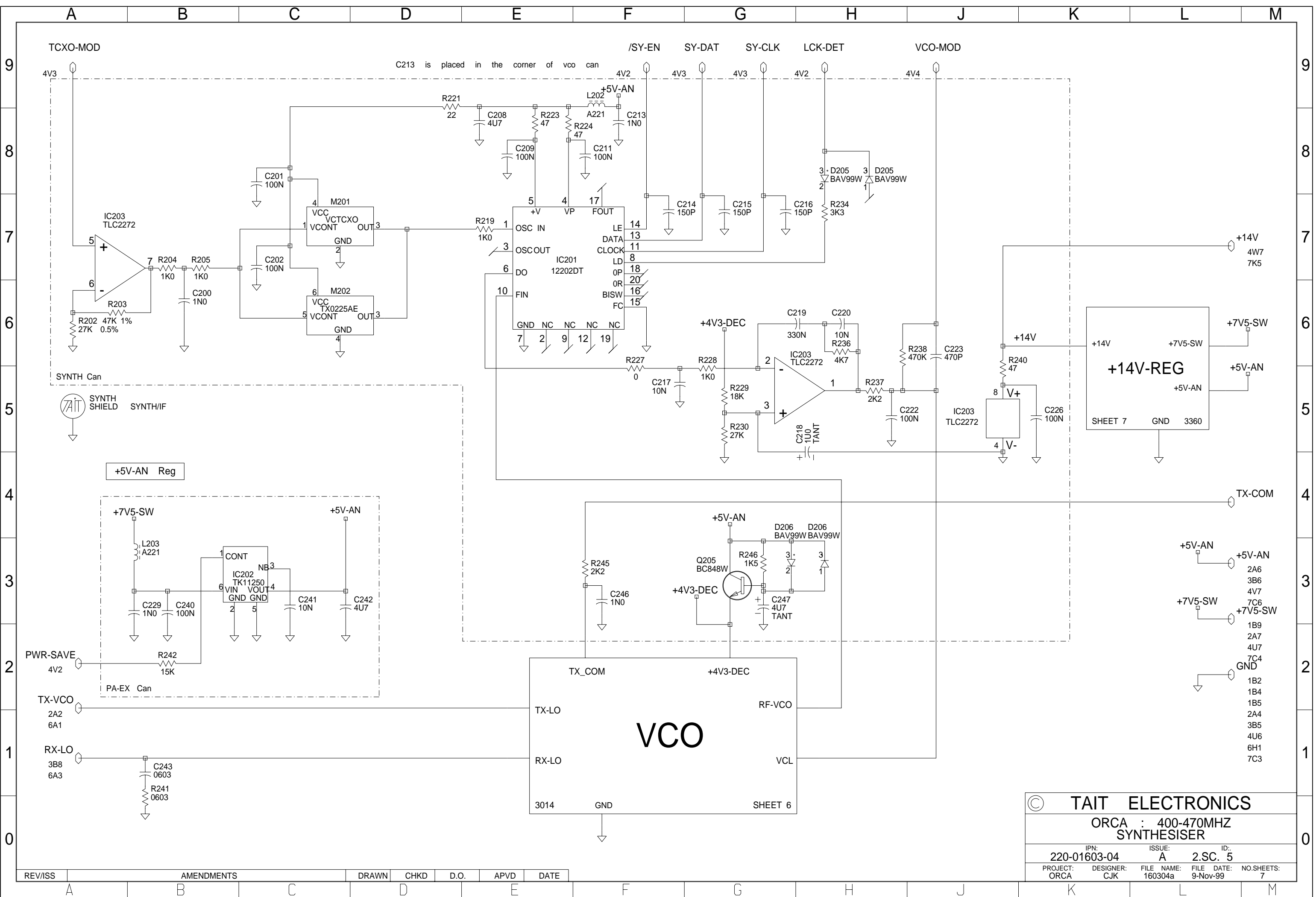

C213 is placed in the corner of vco can

+14V-REG
SHEET 7
GND 3360

VCO
SHEET 6
3014 GND

© TAIT ELECTRONICS				
ORCA : 400-470MHZ SYNTHESISER				
IPN:	ISSUE:	ID:		
220-01603-04	A	2.SC. 5		
PROJECT: ORCA	DESIGNER: CJK	FILE NAME: 160304a	FILE DATE: 9-Nov-99	NO.SHEETS: 7

REV/ISS	AMENDMENTS	DRAWN	CHKD	D.O.	APVD	DATE

- +5V-AN 2A6
- +5V-AN 3B6
- +5V-AN 4V7
- +7V5-SW 7C6
- +7V5-SW 1B9
- +7V5-SW 2A7
- +7V5-SW 4U7
- +7V5-SW 7C4
- GND 1B2
- GND 1B4
- GND 1B5
- GND 2A4
- GND 3B5
- GND 4U6
- GND 6H1
- GND 7C3

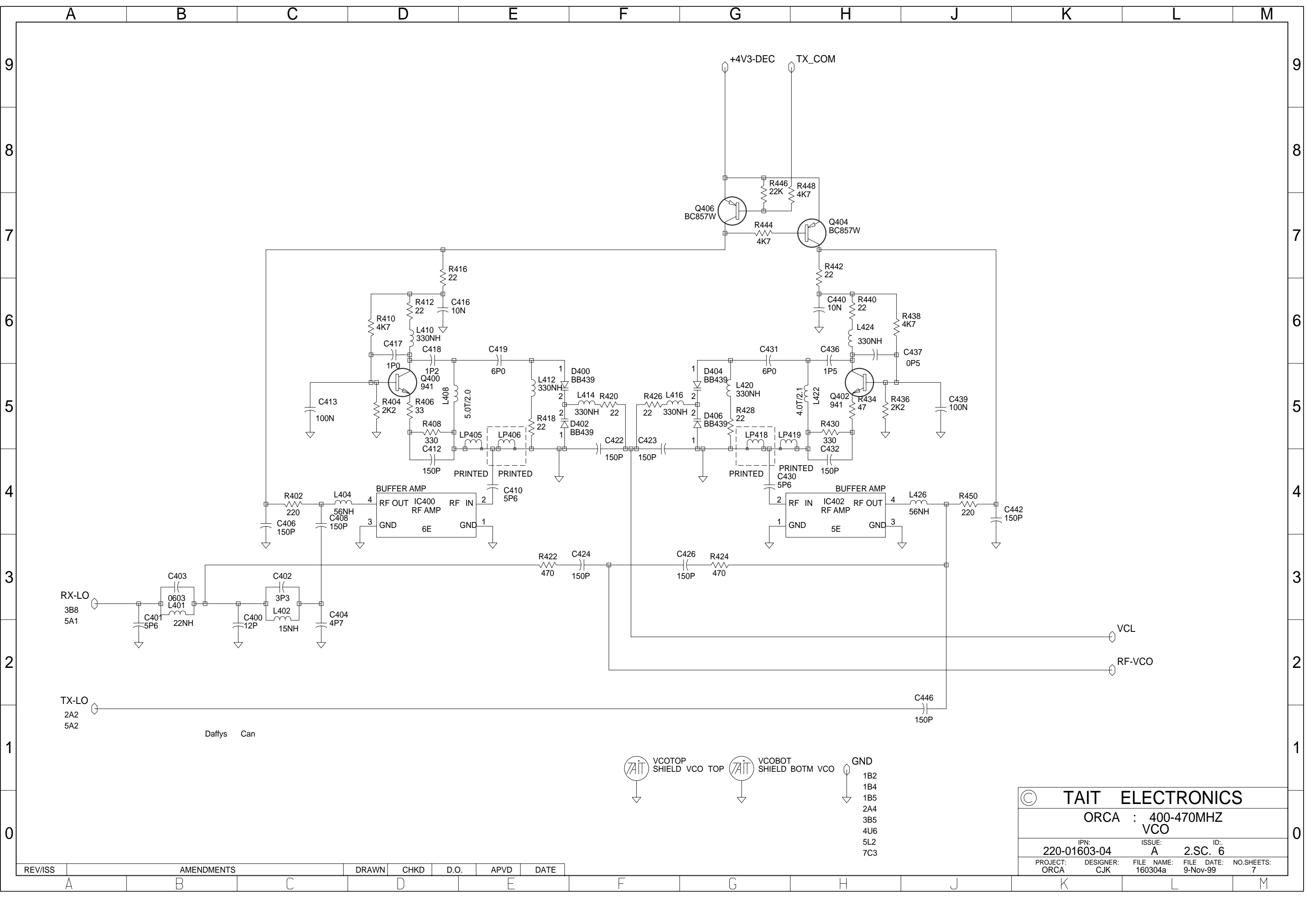

© TAIT ELECTRONICS
 ORCA : 400-470MHZ VCO
 IPN: 220-01603-04 ISSUE: A ID: 2.SC. 6
 PROJECT: ORCA DESIGNER: CJK FILE NAME: 160304a FILE DATE: 9-Nov-99 NO.SHEETS: 7

REV/ISS	AMENDMENTS	DRAWN	CHKD	D.O.	APVD	DATE

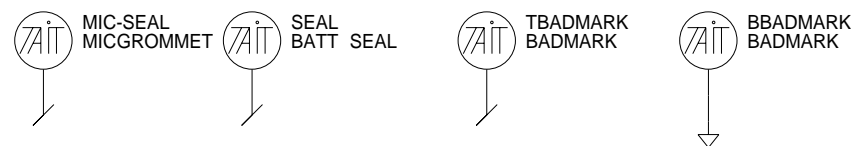
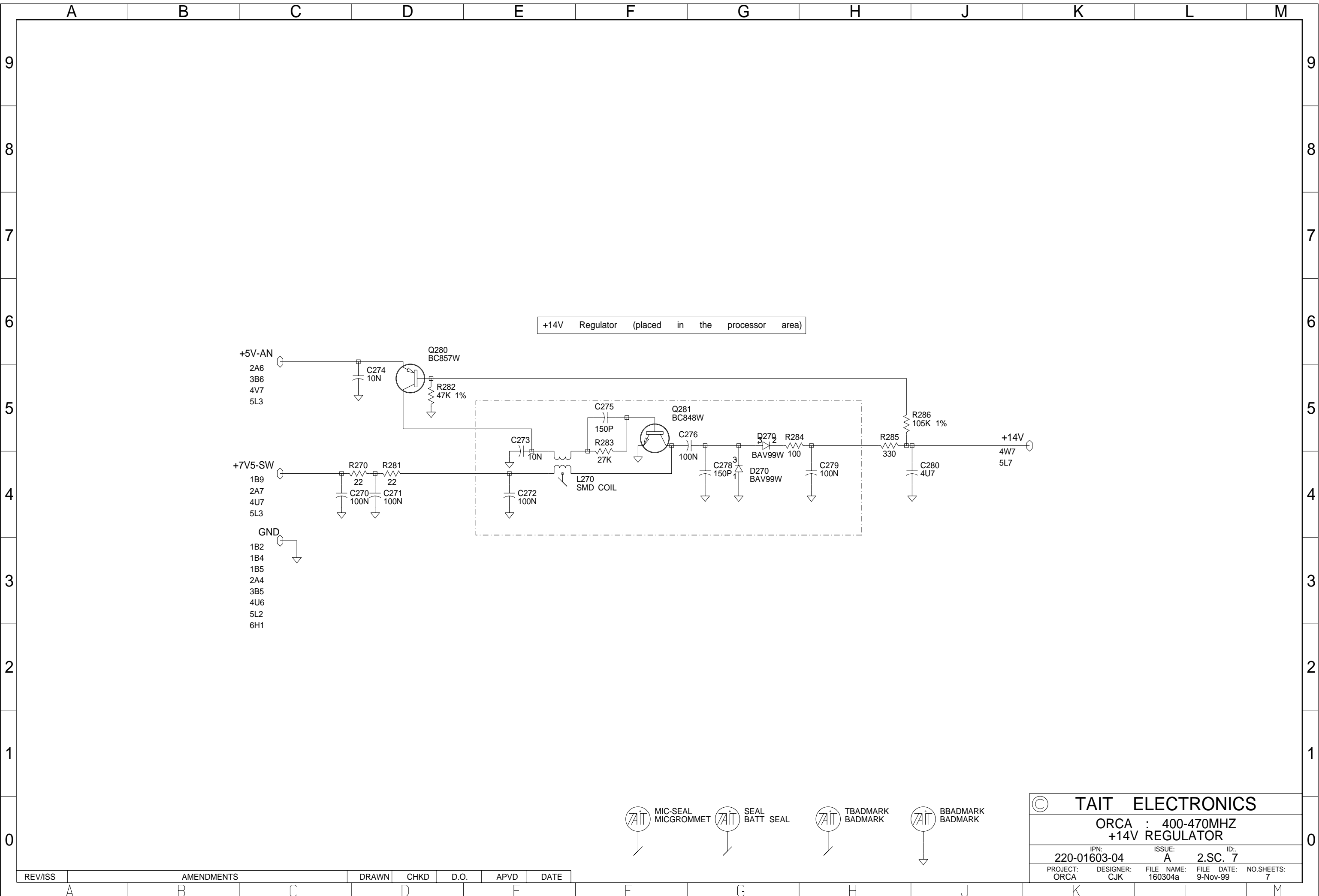

© **TAIT ELECTRONICS**

ORCA : 400-470MHZ
+14V REGULATOR

IPN: 220-01603-04 ISSUE: A ID: 2.SC. 7

PROJECT: ORCA	DESIGNER: CJK	FILE NAME: 160304a	FILE DATE: 9-Nov-99	NO.SHEETS: 7
---------------	---------------	--------------------	---------------------	--------------

REV/ISS	AMENDMENTS	DRAWN	CHKD	D.O.	APVD	DATE

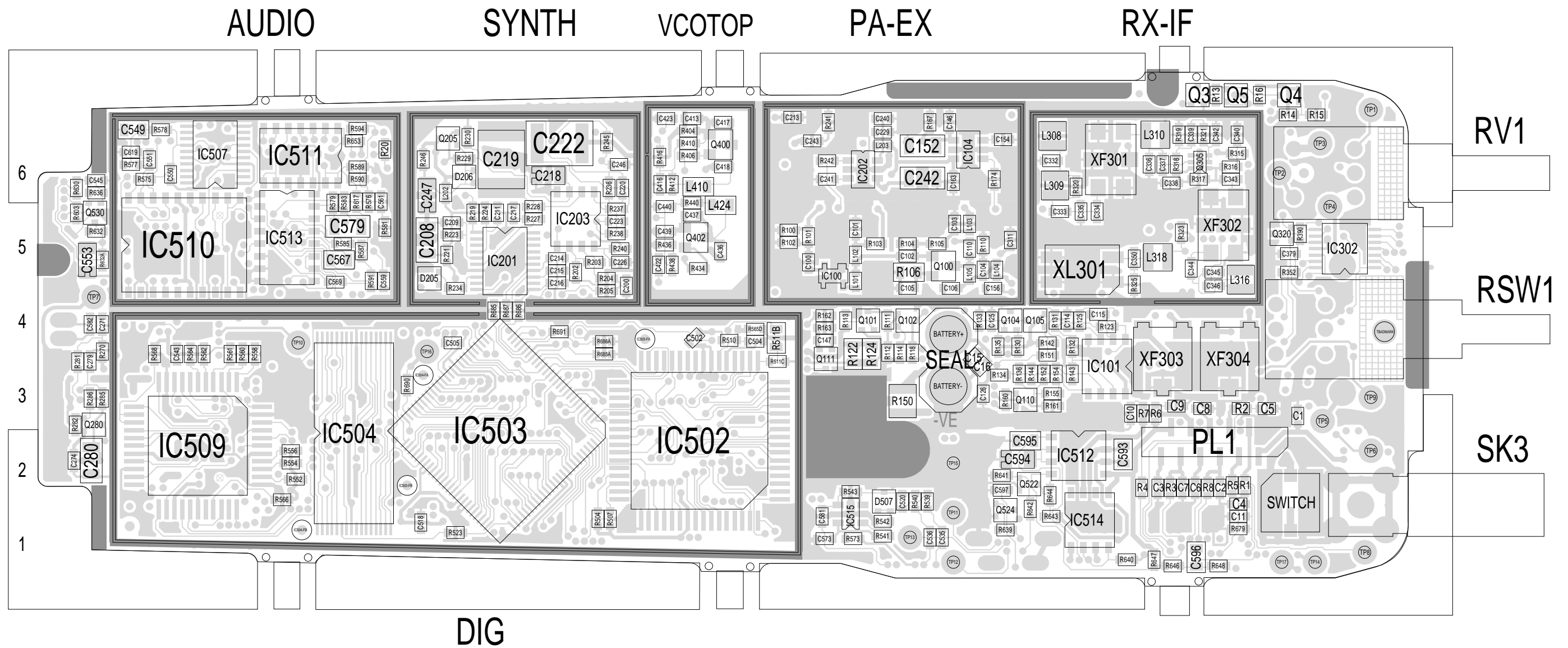

TAIT ELECTRONICS	IPN: 220-01603-04	ISS: A	ID: 1.TA	DATE: 5 Nov 1999
ORCA UHF PCB LAYOUT - TOP SIDE				

Scale: 2.3:1 ; Rotation: 0 degrees

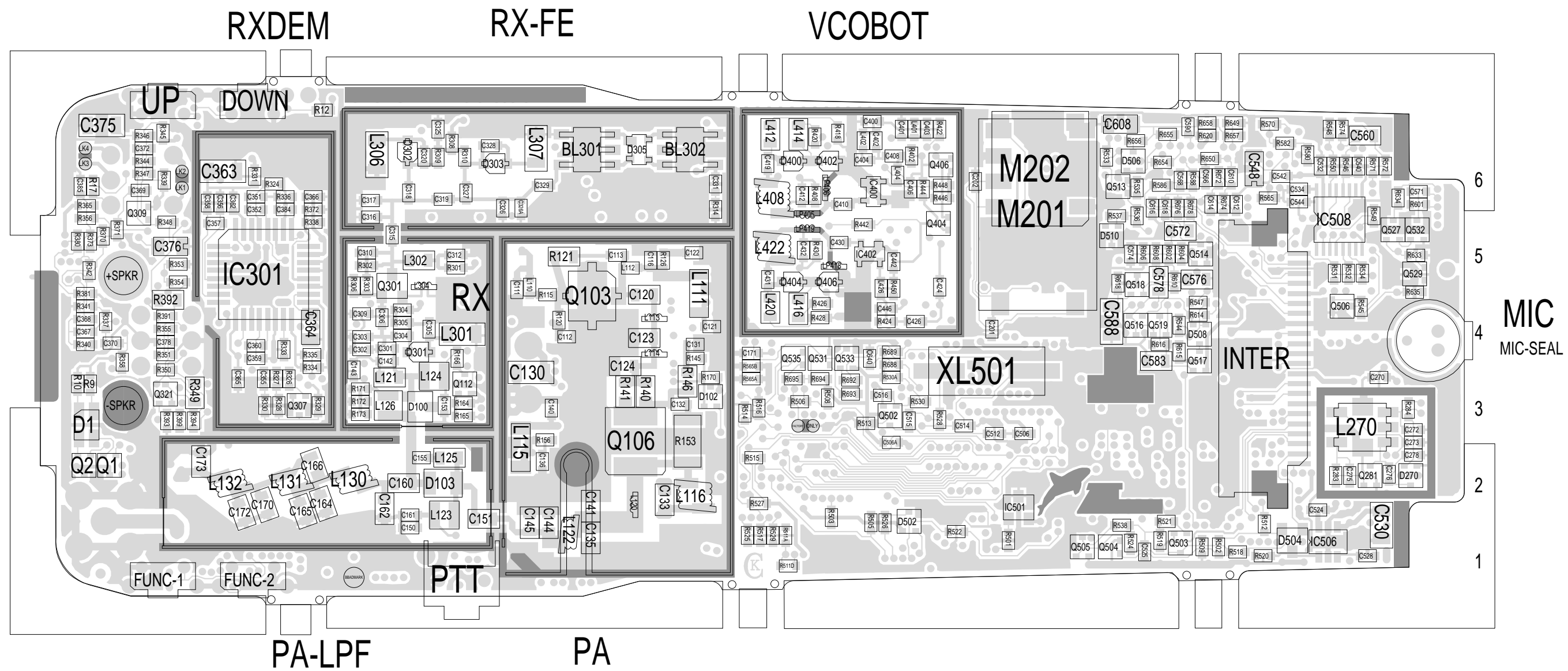

TAIT ELECTRONICS IPN: 220-01603-04 ISS: A ID: 6.BA DATE: 5 Nov 1999
 ORCA UHF PCB LAYOUT - BOTTOM SIDE